

Name:

Class/Set:

# Pythagoras' Theorem

1: Find the unknown quantity (correct to 1 decimal place):

a)

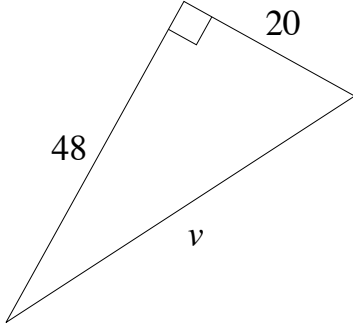

\_\_\_\_\_

b)

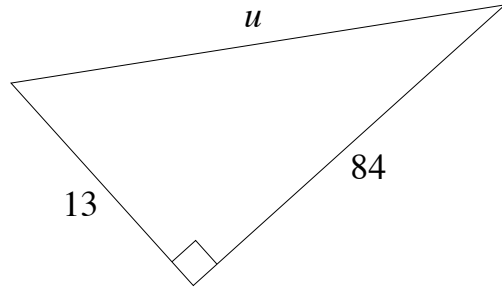

\_\_\_\_\_

c)

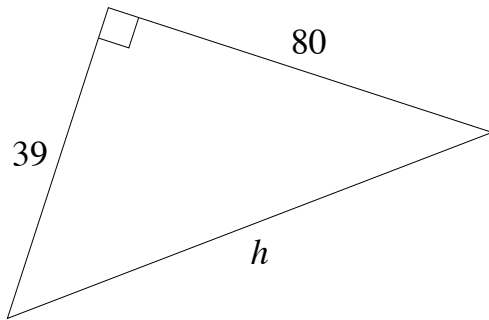

\_\_\_\_\_

d)

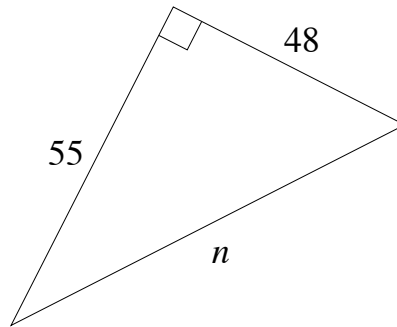

\_\_\_\_\_

e)

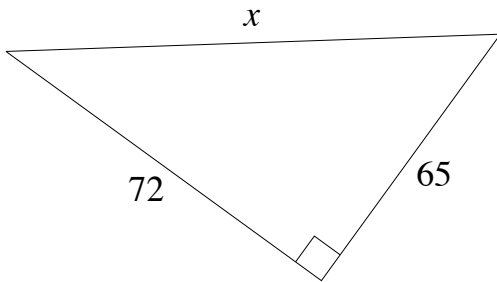

\_\_\_\_\_

f)

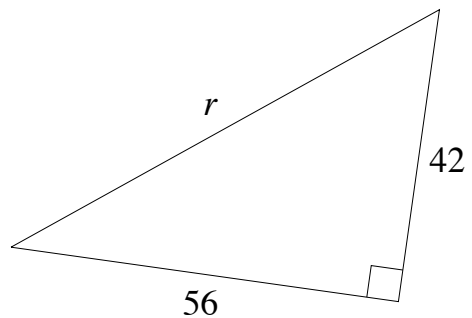

\_\_\_\_\_

2: Find the unknown quantity (correct to 1 decimal place):

a)

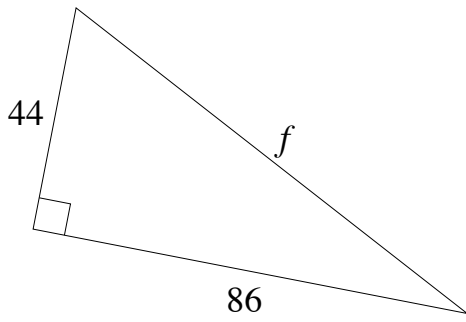

b)

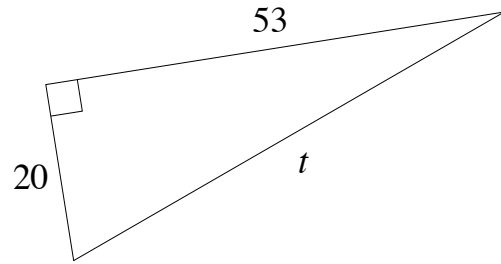

c)

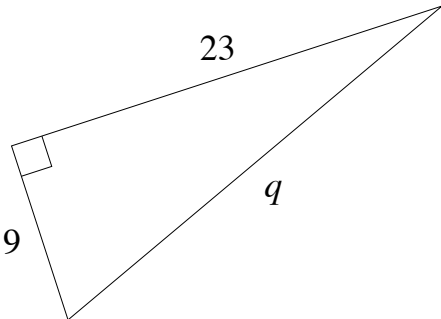

d)

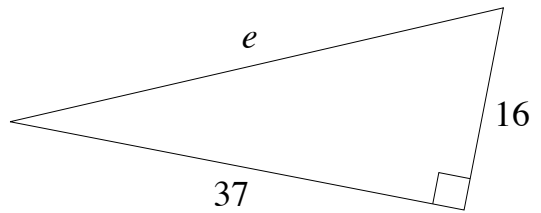

e)

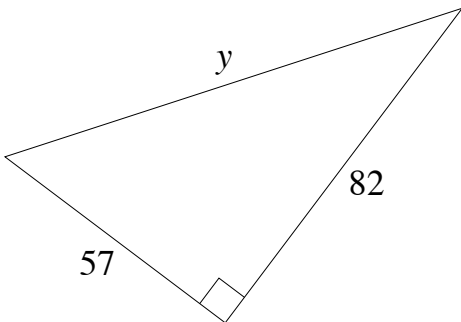

f)

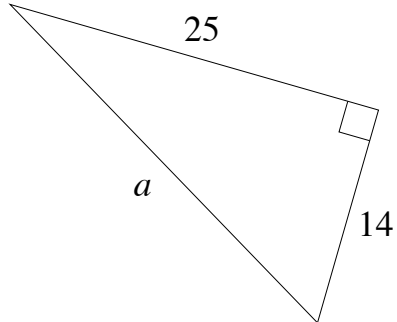

3: Find the unknown quantity (correct to 1 decimal place):

a)

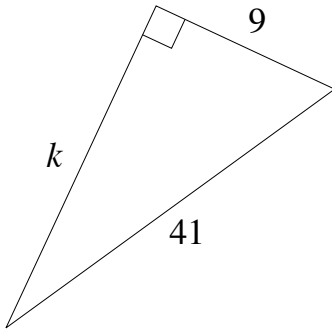

b)

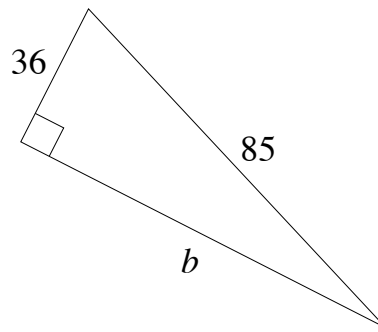

c)

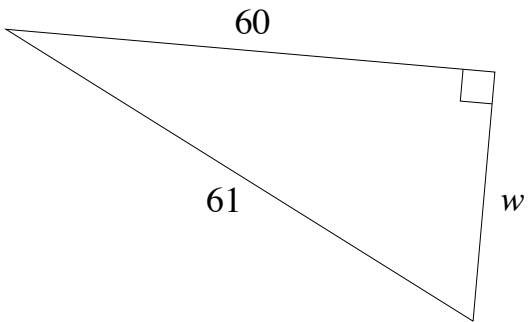

d)

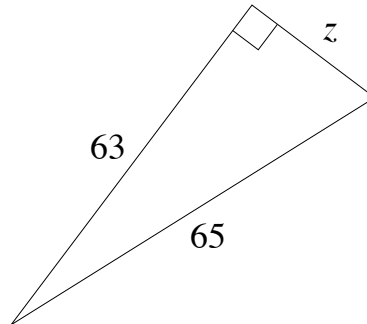

e)

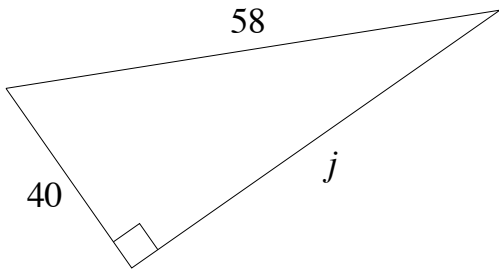

f)

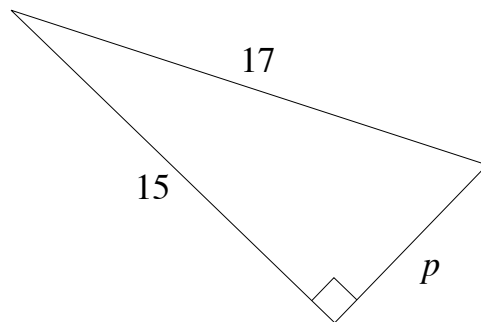

4: Find the unknown quantity (correct to 1 decimal place):

a)

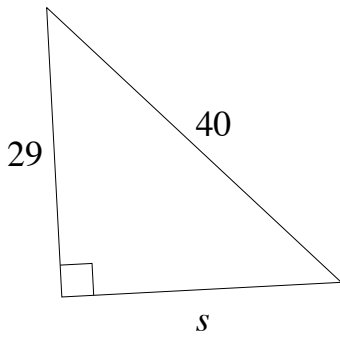

b)

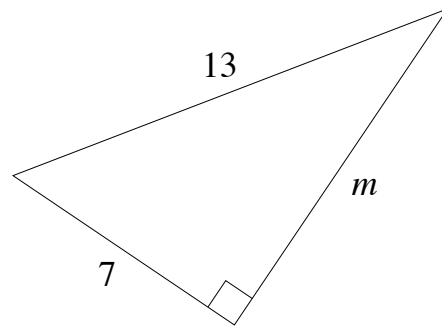

c)

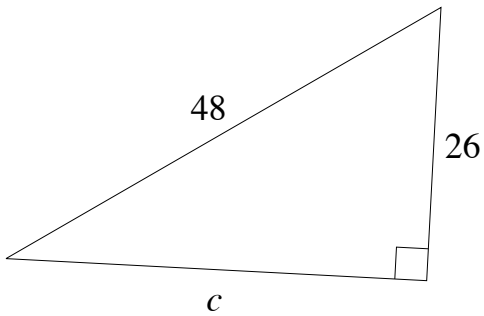

d)

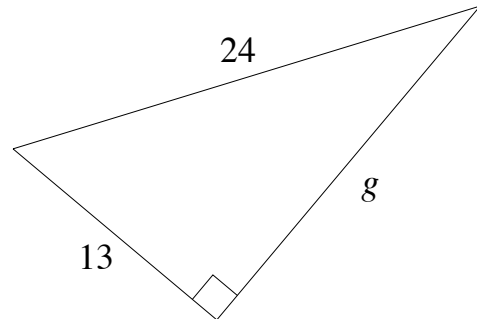

e)

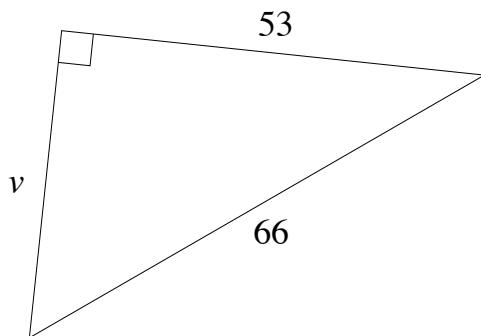

f)

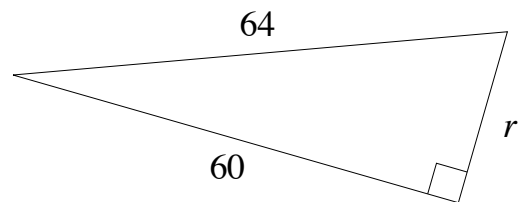

5: Find the unknown quantity (correct to 1 decimal place):

a)

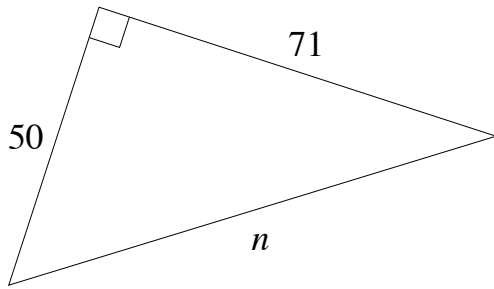

b)

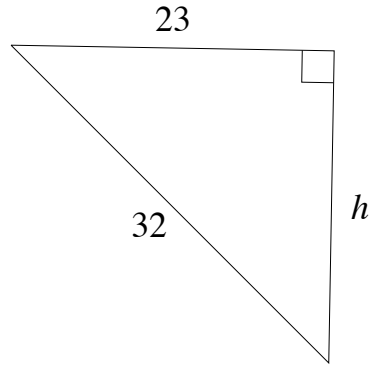

c)

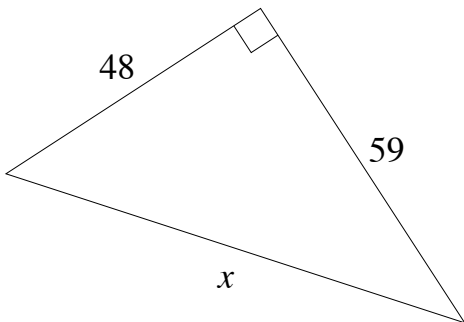

d)

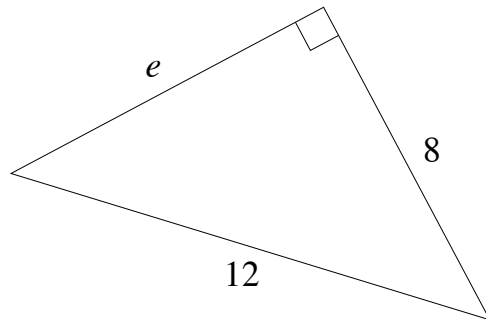

e)

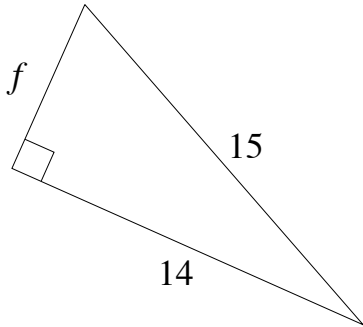

f)

